

MOM2 MOM2 Win

Microhmmeter

User's Manual



Megger

WWW.MEGGER.COM

MOM2

MOM2 Win

Microhmmeter

User's Manual

NOTICE OF COPYRIGHT & PROPRIETARY RIGHTS

© 2011, Megger Sweden AB. All rights reserved.

The contents of this manual are the property of Megger Sweden AB. No part of this work may be reproduced or transmitted in any form or by any means, except as permitted in written license agreement with Megger Sweden AB. Megger Sweden AB has made every reasonable attempt to ensure the completeness and accuracy of this document. However, the information contained in this manual is subject to change without notice, and does not represent a commitment on the part of Megger Sweden AB. Any attached hardware schematics and technical descriptions, or software listings that disclose source code, are for informational purposes only. Reproduction in whole or in part to create working hardware or software for other than Megger Sweden AB products is strictly prohibited, except as permitted by written license agreement with Megger Sweden AB.

TRADEMARK NOTICES

Megger® and Programma® are trademarks registered in the U.S. and other countries. All other brand and product names mentioned in this document are trademarks or registered trademarks of their respective companies.

Megger Sweden AB is certified according to ISO 9001 and 14001.

Megger Sweden AB
Eldarvägen 4
Box 2970
SE-187 29 TÄBY
Sweden

T +46 8 510 195 00
F +46 8 510 195 95
seinfo@megger.com
www.megger.com



Contents

1 Safety

.....	6
Symbols on the instrument	6
Safety instructions	6

2 Introduction

.....	8
-------	----------

2.1 Basic technical description.....	8
Kelvin test.....	8
2.2 DualGround – Both sides grounded	9



3 MOM2 overview

.....	10
-------	-----------

3.1 The instrument	10
3.2 Accessories	12
3.3 Optional accessories.....	12

4 Functions and set up

.....	14
-------	-----------

4.1 General.....	14
Internal software version.....	14
4.2 Test positions	14
4.3 Bluetooth – 	15
SET/ 	15
4.4 Clock – CLK	17
SET/CLK.....	17
4.5 Minimum current – I min	18
SET/I min.....	18
4.6 Data logger – LOG	18
SET/LOG	18
4.7 Pass/Fail – P/F	19
SET/P/F.....	19
4.8 PC communication – PC COM	20
PC COM	20
4.9 Audio signals	20
4.10 Battery power supply	21
Charging	21
Replacing the batteries	21
Battery practice.....	21

5 Operating instructions

.....	22
-------	-----------

5.1 General instructions	22
Important regarding all testing.....	22
Power supply	22
LCD display.....	22

To choose measurement time	22
To choose $I > I_{min}$ or $I = I_{max}$	22
Working at low temperatures	23
Kelvin Clamp/Probe practice	23
Save test results	23
Hold present test result.....	23
Delete present test result	23
Recalling test results from the log	23
Delete results in the log	23
Delete all results in the log.....	23

5.2 Measurement with max. charge, $I = I_{MAX}$	24
5.3 Measurement with minimum current guarantee, $I > I_{min}$	25
5.4 Measurement using P/F – pass/fail.....	26
5.5 Measurement with user defined settings.....	27
5.6 Measurement using the LOG function.....	27
Running numbers mode	27
Circuit breaker testing mode.....	27
5.7 Measurement using P/F and I min	29
5.8 Trouble shooting.....	30
Error messages	30

6 Application examples

.....	32
-------	-----------

6.1 Safety	32
Important regarding all testing.....	32
6.2 Measurement using Kelvin probes.....	32
6.3 Test a CB using DualGround.....	33
6.4 Test a CB by injecting through the ground cables.....	33
Disconnection.....	33

8 MOM2 Win

.....	34
-------	-----------

8.1 Introduction	34
8.2 MOM2 installation	34
Preconditions.....	34
Setup.....	34
Select language	34
8.3 Start MOM2 Win	35
Exit MOM2 Win.....	35
8.4 Connecting to MOM2.....	35
Automatic connecting	35
Manual connecting.....	35
8.5 Read the measurement log	37
Export data to file	38
Delete all data on the instrument.....	39
8.6 User settings.....	39

Read existing settings	39
Program "User" positions	39
8.7 Calibration.....	40
Required equipment	40
Procedure	40
Voltmeter calibration	40
Ammeter calibration	40
Calibration report	41
9 Specifications	
.....	42
Specifications MOM2	42
Index	44

1 Safety

For your own safety and to get the maximum benefit from your instrument, please ensure that you read and understand the following safety instructions and warnings before using the instruments.

Symbols on the instrument



Caution, refer to accompanying documents.



Protective conductor terminal.



WEEE, Waste Electrical and Electronic Equipment. Please utilize your local WEEE collection facilities in the disposal of this product and otherwise observe all applicable requirements.



Equipment complies with current EU directives.

Safety instructions



Important

Read and comply with the following instructions.

Always comply with local safety regulations.

Warning

1. Before measuring resistance in circuit breakers or disconnecting switches (isolators), always check to see that the object being tested is closed and grounded at both sides.
2. If there are current transformers in MOM2's test circuit, follow the normal procedure to demagnetize current transformer cores, after completing your measurements.
3. Never open a circuit breaker while MOM2 is connected to it.
4. Connection points for current cables can become hot during current generation.
5. High current on output terminals.
6. Do not attempt to service the instrument yourself. If you attempt to service the instrument yourself the warranty is no longer valid.
7. Do not use any accessories that are not intended for use together with the instrument.
8. Use a damp cloth for cleaning. Do not use liquid cleaners or aerosol cleaners.

Important

1. The instrument is intended for use in industrial environment. It generates, uses and can radiate radio frequency energy and, if not installed and used in accordance with these instructions it may cause interference to other devices in the vicinity. If this equipment does cause interference with other devices, which can be determined by turning the equipment off and on, the user is encouraged to try to correct the interference by one or more of the following measures:
 - Reorient or relocate the receiving device.
 - Increase the separation between the equipments.
 - Connect the equipment into an outlet on a circuit different from that to which the other device(s) is connected.
 - Consult the manufacturer or field service technician for help.
2. Never leave the MOM2 unattended while it is turned on.
3. It is not possible to use the MOM2 for testing during battery charging.
4. Refer all servicing to Megger authorized personnel.
5. If you need to return the instrument, please use either the original crate or one of equivalent strength.

2 Introduction

The MOM2 is designed to measure the resistance of circuit breaker contacts, bus-bar joints, contact elements in bus-bars and other high-current links.

When contact resistance rises because of oxidation, loosened or improperly tightened threaded joints, temperatures rise abnormally at the points of contact. This abnormal heating reduces conductivity thereby accelerating the rise in temperature — and this often leads to serious trouble.

The MOM2 microhmmeter can be used to detect such problems early so that they can be remedied long before trouble starts. Checking contact resistance at regular intervals provides a clear indication of the state of your system.

2.1 Basic technical description

The output current is delivered from a supercapacitor which is charged from the built-in rechargeable batteries.

Kelvin test

The MOM2 uses Kelvin probes or clamps for the measurement. A Kelvin test uses four wires and measures continuity resistances ensuring all contact and lead resistances are compensated for, which allows a much greater accuracy in measurements. Each Kelvin probe assembly has two probe tips. When contacting the test object it will be contacted with two plus two probe tips. One pair is for the current generated. The other pair will measure the very small voltage present.

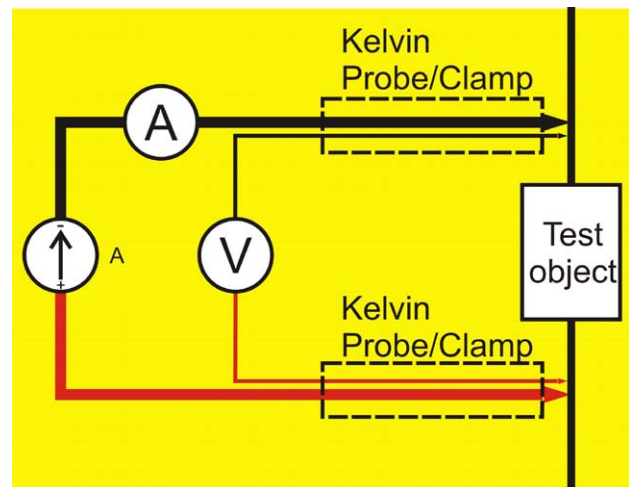

Principle for the 4 wire Kelvin test.

2.2 DualGround – Both sides grounded

With MOM2 it is possible to make measurements according to the DualGround™ method. The most important advantage is improved safety but the method is also easier and saves time. The number of tasks is reduced when the ground cable does not need to be disconnected and reconnected. Permission related work that may include paper work could many times be avoided. However, the local safety regulations shall always be followed.

Using the DualGround method might cause a small measurement error cause by the current running through the ground loop. The error value depends on the relation between the two parallel circuits.

Example: If the test object is $50 \mu\Omega$ and ground loop is $10 \text{ m}\Omega$ the error will be 0.5%

Two 10 m, 95 mm² grounding cables has a resistance of around 3.6 m Ω . Transitional resistance in connections and clamps to be added.

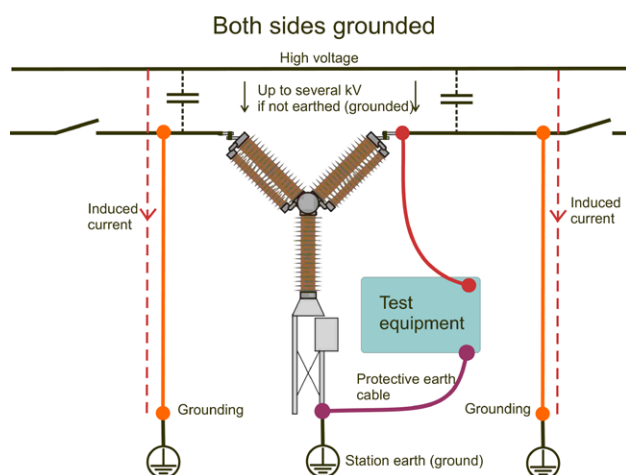

With both sides grounded the induced current will not pass through the test instrument.

3 MOM2 overview

3.1 The instrument



Top view

Bottom view

1.	Current output terminal (-)										
2.	Current output terminal (+)										
3.	Protective conductor terminal										
4.	<p>Display</p> <ul style="list-style-type: none"> ■ The display offers a combination of analogue arc and a dual digital readout: ■ Analogue arc: Shows the capacitor charge. ■ Dual digital display: Large main digital readout for good visibility of all main measurement results Second digital display for additional data. 										
5.	<p>Keys</p> <p>Keys for navigation and to make settings in the display .</p> <table border="1"> <tr> <td>◀▶</td> <td>Left, right is used to navigate between characters/digits.</td> </tr> <tr> <td>▲▼</td> <td>Up, down is used to change each character/digit.</td> </tr> <tr> <td>OK</td> <td>Press and hold to enable edit of parameters select and confirm parameters. Press shortly to confirm.</td> </tr> <tr> <td>☀</td> <td>Backlight Automatic switch off after 20 s.</td> </tr> <tr> <td>C</td> <td>Clear / Cancel</td> </tr> </table>	◀▶	Left, right is used to navigate between characters/digits.	▲▼	Up, down is used to change each character/digit.	OK	Press and hold to enable edit of parameters select and confirm parameters. Press shortly to confirm.	☀	Backlight Automatic switch off after 20 s.	C	Clear / Cancel
◀▶	Left, right is used to navigate between characters/digits.										
▲▼	Up, down is used to change each character/digit.										
OK	Press and hold to enable edit of parameters select and confirm parameters. Press shortly to confirm.										
☀	Backlight Automatic switch off after 20 s.										
C	Clear / Cancel										
6.	<p>TEST button</p> <p>When the function selector is in any of the positions I > I min, I = I max or USER measurement is performed by pressing the button.</p>										
7.	<p>Stand-by / Wake up</p> <p>Press shortly to toggle</p> <p>Clear log (Press and hold for 5 s)</p>										

8.	Function selector		
	OFF		
	I > I min	0.1 s	Test positions
		0.6 s	Measurement time with minimum current guarantee
		3 s	
	I = I max	0.1 s	Test positions
		0.6 s	Measurement time with max. charge
		3 s	
	SET	Bluetooth	Bluetooth "pair units"
		CLK	<ul style="list-style-type: none"> ■ Set date and time ■ Set volume for the internal buzzer ■ Discharge the MOM2 internal capacitor
		I min	Minimum current guarantee setting
		LOG	Data log settings
		P/F	Pass/Fail settings
	PC COM		PC communication (dump data to PC)
	USER	1	Test positions
		2	Stored settings (Set from PC SW)
		3	
9.	Input for sensing voltage (-)		
	Connector for the negative test lead.		
10.	Input for sensing voltage (+)		
11.	Connector for trigger		
12.	Battery lid		
13.	Connector for the battery charger		
14.	Battery charging indicator		

3.2 Accessories

- Test cables with Kelvin probes (one with trigger)
or
Test cables with Kelvin clamps
- Transport case
- Charger
- Rubber holster
- Carrying strap
- Belt clip
- MOM2 Win

3.3 Optional accessories

Test cables with Kelvin probes	
2 x 1.3 (4 ft) m (one with trigger)	GA-90000
Test cables with Kelvin clamps	
1.3 m (4 ft) red, 3 m (10 ft) black	GA-90001
Cable kit 5 m	
Current cable 0.5 m (1.6 ft), Connection plate and sense cables 5 m (16 ft), Ground cable	GA-00380
Cable kit 10 m	
Current cable 0.5 m (1.6 ft), Connection plate and sense cables 10 m (33 ft), Ground cable	GA-00382
Cable kit 15 m	
Current cable 0.5 m (1.6 ft), Connection plate and sense cables 15 m (49 ft), Ground cable	GA-00384
Bluetooth kit	
Bluetooth headset and dongle for PC	XC-06000
Calibration kit	BD-90002

4 Functions and set up

4.1 General

Internal software version

When turning the function selector from OFF to any position the display will shortly show a number e.g. 008 and then during five seconds the internal software version e.g. "01C" (revision R01C).



OFF

The instrument should be in the **OFF** position when not in use.

Note *The MOM2 will go to stand by mode after about 10 minutes of inactivity. To wake up, press Stand-by / Wake up (CLR LOG) button.*

4.2 Test positions

> I min

Minimum current is set in position **SET / I min**.
Generation/measurement time: 0.1 s, 0.6 s or 3 s.

= I max

The current is only limited by the total impedance of the circuit.
Generation/measurement time: 0.1 s, 0.6 s or 3 s.

USER / 1, 2, 3

User defined settings as generation time, I min, pass/fail and log.

Note *The user defined settings can only be set via MOM2 Win from a PC*

4.3 Bluetooth –

SET /

Display abbreviations

SEt	Set
SPC	Set-up PC
SHS	Set-up headset
Prd	Paired
E-d	Enable / Disable (headset)
EnA	Enabled (headset)
diS	Disabled (headset)
o	Processing
ErA	Erase all addresses

Enable / Disable Bluetooth

- 1] Use the ◀ ▶ keys to find "E-d".
- 2] Press OK to toggle between "EnA" (Enabled) and "diS" (Disabled).

Note *Do not use the PC COM mode if there is a requirement for non-electromagnetic interference in the environment.
The PC COM position is always enabled as it overrides the disable setting.*

Set up Bluetooth

- 1] Select SET /  on the MOM2.



- 2] Press ▶, "SPC" will be shown.
- 3] Press "OK". Display will show "o".
The MOM2 is now visible in the Bluetooth network and ready to be paired.
- 4] On the PC, in the "Control Panel" select "Bluetooth Devices".
- 5] Click "Add".

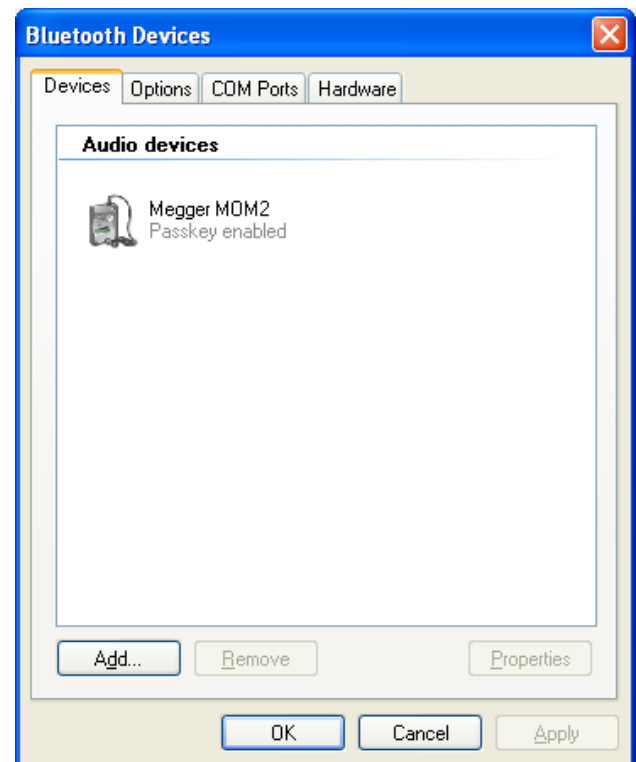

- 6] Check the box and click "Next".



- 7] The PC should now find the MOM2.

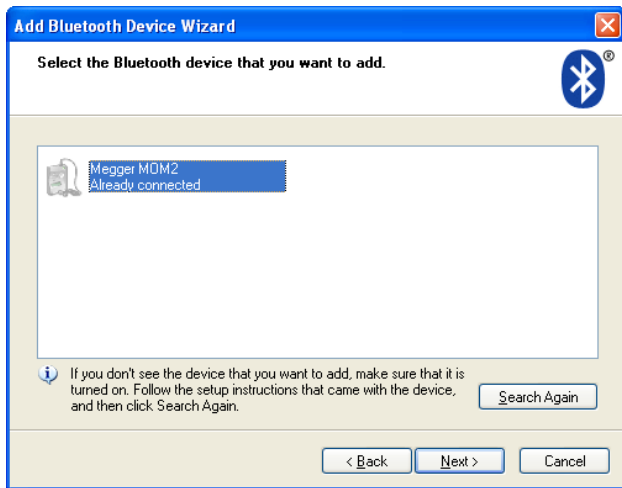

- 8] Check and click Next.
- 9] Select the second option, see below, enter "0000" and click Next.

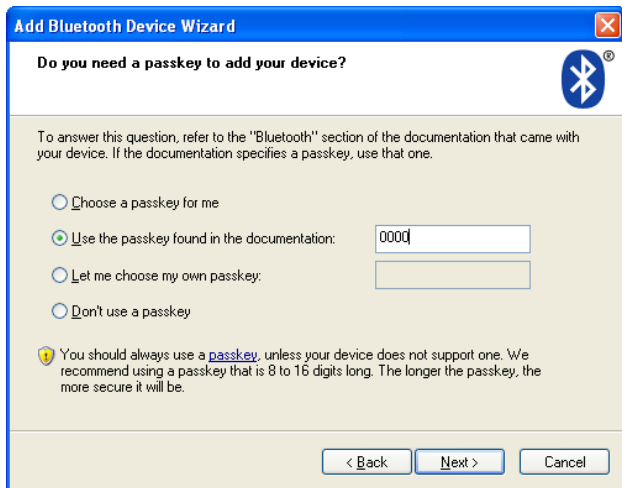

- 10] Display shows "Prd" and set up is complete.

Note *The procedure to pair and assign com port varies depending on the equipment.*

How to pair a headset

- 1] Select SET/Bluetooth on the MOM2.
- 2] Use the ◀▶ keys to find out that Bluetooth

is enabled, "EnA".

- 3] Press right arrow key twice. The display shows "SHS"
- 4] Set the headset in pair mode (See the instructions for the headset.)
- 5] Press the OK key on the MOM2.
- 6] When the display shows "Prd" the pairing is ready.

How to start the headset

- 1] See the instructions for the headset



4.4 Clock – CLK

SET/CLK

There are three functions in this position:

- A]** Set date and time.
- B]** Set volume for the internal buzzer.
- C]** Discharge the MOM2 internal capacitor, (used for service only).

Display abbreviations

CLC	Clock
UOL	Volume
dIS	Discharge (used for service only)
yy	Year
non	Month
dd	Day
HH	Hour
nIn	Minute

Date and time

- 1] Select **SET/CLK**



- 2] Press and hold OK key until digits start to blink under the "yy" letters.



- 3] Set year using the ▲ ▼ keys.
- 4] Press OK key.
- 5] Press the ► key to go further and set month, day, hour and minute in the same way as above.
- 6] Press C key to return.

Volume for buzzer

- 1] Select **SET/CLK**
- 2] Press ► key, "UOL" is shown.
- 3] Press and hold OK key until digit start to

blink.

- 4] Set level (1 to 5) using the ▲ ▼ keys.
- 5] Press OK key.
- 6] Press ► or ◀ to return.

4.5 Minimum current – I min

SET / I min

Display abbreviations

SEL	Select
-----	--------

Set-up

- 1] Select **SET / I min**. Present setting is displayed.
- 2] Press and hold OK key until digits start to blink under the "SEL" letters.
- 3] Select value, 50 or 100, using the ▲ ▼ keys.



- 4] Press OK key to confirm.
To cancel press C key or turn the function selector to another position.

Result after a measurement

If the chosen value is not reached during a measurement it will result in a notification on the display and by an audio signal.

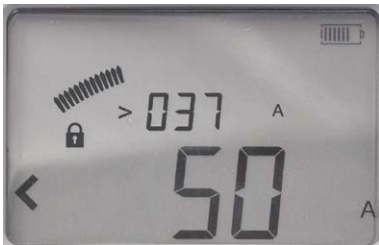

Picture shows an example after a measurement. The I min limit "50 A" has not been achieved, indicated by the "<" character to the left. The current measured during the test is shown in the upper row. The value shown toggles between the max and min current during the test. In this case it is the minimum current showing "> 037 A".

4.6 Data logger – LOG

The data memory can store totally 190 measurements and this capacity is shared by the two log modes.

SET / LOG

Display abbreviations / description

SEL	Select
oFF	OFF
1A1	Label for Breaker, Phase, Interrupter
1234	Running numbers

LOG modes

OFF



When the log is OFF only the latest value is stored and only until the performance of a following measurement, which overwrites the previous one.

Circuit breaker testing mode, 1A1



This mode is primarily designed for measurement on circuit breakers. The three characters (1A1) are supposed to indicate: Breaker, Phase, Interrupter.

Measurement is automatically stored, provided that there are less than three measurements stored on the selected object label. Each label can store three measurements. See also section 5.6 Measurement using the log function.

Running numbers mode, 1234



The measurements are numbered in numerical order (1 to 1999)

Measurement is automatically stored, provided that the memory is not full.

Set-up

- 1] Select **SET/LOG**. Present setting is displayed.
- 2] Press and hold **OK** key until characters start to blink under the "SEL" letters.
- 3] Use the **▲▼** keys to select mode.
- 4] Press **OK** key.

4.7 Pass/Fail – P/F

In the P/F position you can enable and set the limit for the Pass/Fail function. If the measured value exceeds the set limit it will result in a notification on the display and by an audio signal

SET/P/F

Display abbreviations

SEL	Select
oFF	OFF

Set-up

- 1] Select **SET/P/F**. Present setting is displayed.
- 2] Press and hold **OK** key until character, "<" or "oFF" start to blink.



- 3] Select "oFF" or a value using the **▲▼** keys.
- 4] Use the keys **▶◀** to select the digit to change, it will blink.
- 5] Use the keys **▲▼** keys to set the desired value.
- 6] Press **OK** key.
To cancel press **C** key or turn the function selector to another position.

4.8 PC communication – PC COM

The PC COM position is used for all operations performed from a PC using MOM2 Win. You can:

- Dump measurement data from the MOM2
- Delete all measurements in the data log
- Program "User" positions
- Set MOM2 clock
- Calibrate

PC COM

Display abbreviations

rEn	Remote
-----	--------















Set-up

The following is needed:

- A PC with MOM2 Win installed
See chapter 8 MOM2 Win
- A PC connected via Bluetooth
See section "Bluetooth set up"

4.9 Audio signals

The MOM2 emits different sounds to give an audible information / confirmation of an event / action. The sound is emitted from a built-in buzzer and from the Bluetooth headset (optional). The audio signals vary in frequency, Low / High, and composition.

Audio signals	Description
	The MOM2 is charging the capacitor and is not ready for measurement.
	Battery low During capacitor charge
	Measurement in progress
	Pass signal Measurement complete / Pass Wake up
	Fail signal Measurement complete / Fail Label full Stand-by
	When pressing Test/Trigger while lock symbol is shown
	Delete confirmed When press and hold the Test/Trigger Note: Only in LOG mode
	Hold When pressing Test/Trigger Note: Only in LOG mode
	Release When pressing Test/Trigger Note: Only in LOG mode
Legend	 Short - High tone
	 Long - High tone
	 Short - Low tone
	 Long - Low tone
	 Continuous

4.10 Battery power supply

Charging

Before using the MOM2 the batteries should be charged. Use the supplied charger and connect it to the socket at the bottom of the MOM2. Typical recharge time for fully discharged batteries is 3 hours, at 25°C (77°F).

Tip *Place the MOM2 upside down to get better the cooling of the batteries.*

Important

MOM2 cannot be used for testing during charging.



LED indicator	Description	Clarification / Remedy
Green	Fully charged	
Yellow Green	Charging	
Red Yellow Green	Temperature limits exceeded during the charging.	Charging will restart when temperature has decreased.
Red Green	Temperature limits exceeded, too high or too low, before charging.	Charging will start when temperature is within the limits.
Red	Fault state. Wrong battery type, faulty battery.	Disconnect the charger and check the batteries.
None	Battery fault / missing or other fault	Check batteries and charger / cables

Replacing the batteries

1] Loosen the two screws that holds the battery plate at the back of MOM2, see figure below.

It is recommended to use the same type of batteries (AA (HR6) 2700 mAh NiMH) as the original ones.

Note *It is possible to use standard (non-rechargeable) alkaline cells but then only for test using the 0.1 s measurement position and $I > 1$ min.*



Loosen the two screws that holds the battery lid at the back of MOM2.

Important

Always replace all batteries at the same time.
Do not mix old and new batteries.
Do not mix types or brands.

Battery practice

To extend the battery life cycle time it is a good practice to recondition the batteries in a separate charger that has recondition options like refresh / discharge. It is a good idea to condition the batteries once in about 6 months or after around 12 regular charge cycles to get the most out of them.

5 Operating instructions

5.1 General instructions

Important regarding all testing



Important Read and comply with the safety instructions. Always comply with local safety regulations.

Power supply

Prepare testing by charging the batteries see section 4.10 Battery power supply.

Note *The MOM2 cannot be used for testing during battery charging.*

LCD display

The display can be backlighted by pressing the key . It is switched off automatically after 20 seconds.

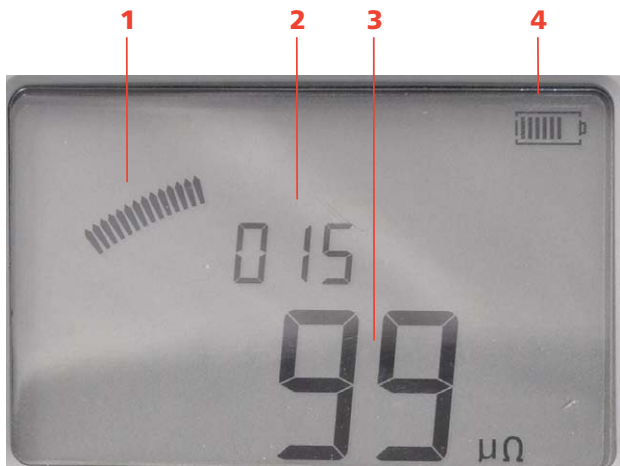

- | | |
|----|--|
| 1. | Analogue arc
Indicates level of the capacitor charge |
| 2. | Measurement label
In this case the instrument is set in Running numbers mode (SET/LOG) |
| 3. | Measurement result |
| 4. | Battery charge indicator |

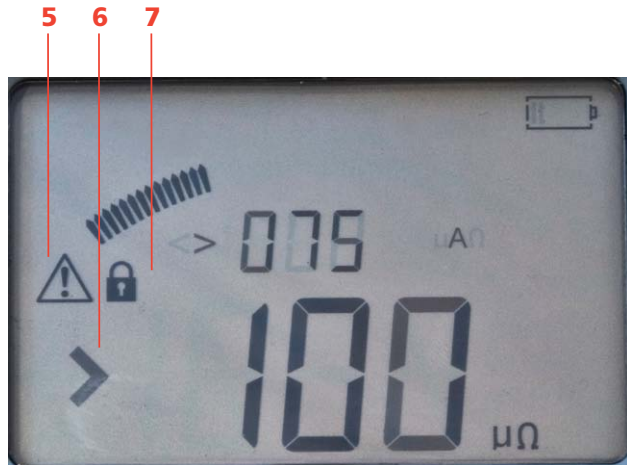

- | | |
|----|--|
| 5. | Warning
See section 5.8 Troubleshooting |
| 6. | Pass/Fail indicator
In this case the Pass/Fail is set to 100 $\mu\Omega$ |
| 7. | Padlock symbol
The lock symbol is shown when the capacitor is charged prior to a test and when you lock a test result. |

To choose measurement time

In an environment without electrical interference it is wise to choose the shortest measurement time, which means that you can get the largest number of measurements on a single battery charge.

Note *The shortest measurement time (0.1 s) is not suitable in environments with a frequency of 16 2/3 Hz.*



Tip: Start making three tests with the shortest measurement time to figure out if the results vary. If they do not differ significantly - use 0.1 s for the tests.

To choose I > Imin or I = Imax

If you want maximum current for your test choose **I = Imax**. In this position the capacitor will be charged to its maximum and therefore requires much energy from the batteries.

If lower current is sufficient for the measurement, it is advisable to use the **I > Imin** position. In the

SET/I min position you select the minimum current to be 50 A or 100 A.

Min current guaranteee (I > I min)	Max current (I = I max)
Valid for test objects $\leq 2 \text{ m}\Omega$	For all test objects, $0 - 1 \Omega$
Capacitor only charged to sufficient level to generate selected minimum current for set time Saves instrument battery	Capacitor is fully charged Will push as much current as possible through the test object for set time. Current is determined as: $I \approx 2.5 \text{ V} / [\text{test object } R + 0.01 \Omega] \text{ A}$
Allows for shorter time between tests	Requires longer capacitor recharge times

Working at low temperatures

MOM2 can be operated down to -20°C provided that the batteries keep a temperature over 0°C . When the instrument is in use the batteries will generate heat enough to keep themselves warm.

Kelvin Clamp/Probe practice

Important

To avoid adding unwanted transition resistances to the measurement result the Kelvin clamps or Kelvin probes shall be connected directly to the test object and not to e.g. a bolt head.

In some cases it might be advisable to use separate sense cables, forming a conventional four point measurement, in order to get a more accurate voltage sense.

Save test results

- A]** When **LOG** is activated measurement results are automatically saved in the memory.
- B]** When the log is OFF only the latest value is stored and only until the performance of a following measurement, which overwrites the previous one.

Hold present test result

When the LOG function is activated the measurement result is shown on the display for about 3 seconds. After that it is stored in the memory. If you want to study the result longer you can lock the display view by doing as follows.

- 1]** Press shortly the trigger on the Kelvin probe or the **TEST** button just after a measurement. The latest test result is locked and shown on the display. This is confirmed by a padlock symbol on the display and an audio signal.
- 2]** To unlock, press shortly the trigger on the

Kelvin probe or the **TEST** button.

Delete present test result

- 1]** Press and hold, about 1 s, the trigger on the Kelvin probe or the **TEST** button just after a measurement.
The latest test result is deleted from screen and log. This is also confirmed by an audio signal.

Note *This is also possible to carry out when the result is locked on display.*

Recalling test results from the log

- 1]** Saved results can be recalled by scrolling to desired label using the **▲▼** keys.

Delete results in the log

- 1]** Select label using the **▲▼◀▶** keys.
- 2]** By pressing the **C** key the display will prompt "**CLR**" in big characters.
- 3]** Delete by pressing the **OK** key. Cancel can be done by pressing the **C** key.

Note *In Circuit breaker testing mode the measurement results will be deleted one at a time.*

Delete all results in the log

- 1]** Press and hold, for 5 s, the red button below the **TEST** button.

Note *This will delete the log memory for both log modes, Circuit breaker testing and Running numbers.*

5.2 Measurement with max. charge, I=I MAX

- 1] Read the section 5.1 General instructions.
- 2] If applicable, connect the ground cable (protective earth).
- 3] Make the desired settings in the SET options. In this example LOG and P/F are disabled (set to OFF).
- 4] Attach the test cables.
- 5] Turn the function selector to desired I=I max position.
The instrument indicates that it is charging the capacitor by a repeated sound and on the display shows alternating "CAP" and "CHG" and the lock symbol.



Charging

- 6] The MOM2 is ready for a measurement when the lock symbol disappears.

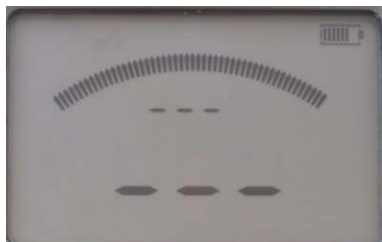

Ready for test

- 7] Press the TEST button on MOM2 or the pull the trigger on the probe.
A continuous audio signal tells that the measurement is in progress.
Two short signals tells that the measurement is complete.
- 8] The result is shown on the display, see figures below.
Over the resistance value "100 μΩ" toggles

the maximal and minimal current values during the test. "268 A" and "250 A"



Pictures shows the two display views..

5.3 Measurement with minimum current guarantee, $I > I_{min}$

- 1] Read the section 5.1 General instructions.
- 2] If applicable, connect the ground cable (protective earth).
- 3] Make the desired settings in the SET options. Select I_{min} to 50 or 100 A (in this example set to 100 A).
In this example LOG and P/F are disabled (set to OFF).
- 4] Attach the test cables.
- 5] Turn the function selector to desired $I > I_{min}$ position.
The instrument indicates that it is charging the capacitor by a repeated sound and on the display shows alternating "CAP" and "CHG" as well as the padlock symbol.



Charging

- 6] When the lock symbol disappears the MOM2 is ready for a measurement.

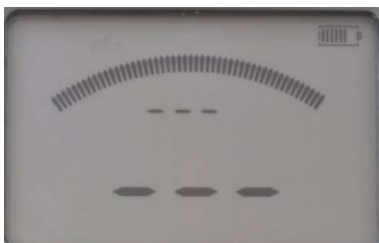

Ready for test

- 7] Press the **TEST** button on MOM2 or **Trigger** on the probe.
A continuous audio signal tells that the measurement is in progress.
Two short signals tells that the measurement is complete.

- A] If the current value is over the set min current limit the result will be shown on the display with big digits.
The small digits toggle between max and min current value.



Pictures shows that the test current was below 219 A and over 205 A.

- B] If the current value is below the set min current limit there is the fail signal and the < character is displayed to the left of the set min current value.



Picture shows that the test current was below 100 A.

5.4 Measurement using P/F – pass/fail

- 1] Make the desired settings in the **SET** options
 Select **P/F** and enter desired limit value.
 In this example **LOG** is set to OFF
 - 2] Turn the function selector to one of the test positions.
 - 3] Press the **TEST** button on MOM2 or the **pull** the trigger on the probe.
 A continuous audio signal tells that the measurement is in progress.
 Another signal tells that the measurement is complete, pass or fail.
- A]** If the resistance value is below the **P/F** limit.
 The result will be shown on the display with big digits.
 The small digits toggle between the **P/F** limit and the max, min current values.



The small digits show the set P/F value (< 90 μΩ).
 The character ">" to the left of the big digits indicates that the P/F value was exceeded.



The minimum current was 80 A and the resistance value is 102 μΩ.



Here P/F limit was set to 150 μΩ and the measured resistance value is 100 μΩ.



Max current during test was 219 A.



Min current during test was 205 A

- B]** If the resistance value is over the **P/F** limit there is the fail signal and the > character is displayed to the left of the set **P/F** value.

5.5 Measurement with user defined settings

There are three positions for storing user defined settings. These can only be set via a PC with the MOM2 Win Software, see chapter MOM2 Win.

5.6 Measurement using the LOG function

See section 4.6 Data logger – LOG for how to set up.

Running numbers mode

The measurements are numbered in numerical order 1 to 1999

Measurement is automatically stored, provided that the memory is not full (Running numbers =1999).



The display before first measurement.

The display after measurements

By using the ◀▶ and ▲▼ keys you can scroll between the saved test results.

Note *You can only scroll through the measurements in the selected LOG mode*

Circuit breaker testing mode

Each label e.g. **1A1** in the memory for the circuit breaker measurement can contain three measurements. These are indicated by commas, see picture below.

The label is built of three elements

- Two-digit indication of circuit breaker (1 to 19)
- A letter for phase (A,B,C)
- Digit for interrupter (1 to 9)

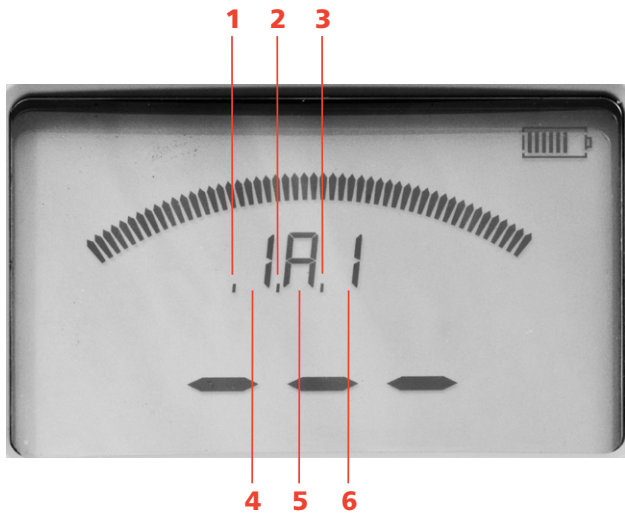

- | | |
|----|---|
| 1. | The first measurement on the present label shown by a comma. |
| 2. | The second measurement in the present memory cell shown by a comma. |
| 3. | The third measurement in the present memory cell shown by a comma. |
| 4. | Digit for the circuit breaker |
| 5. | Letter for the phase |
| 6. | Digit for the interrupter |

The display before measurement



The display before first measurement, one comma:



The display before second measurement, two commas:



The display before third measurement; three commas.

The display after measurements

When three measurements have been done and saved to a label e.g. **1A1** the lock sign is shown.

Note To continue to measure you need to either delete the latest measurement or scroll to a blank label.

By using the ◀▶ and ▲▼ keys you can toggle between the saved test results



The display shows "3" for the third measurement for the specific label. The arrow sign to the left only represents the omitted characters to the left of the digit "3".

To view all measurements stored on the same label

- 1] Press the ▲▼ keys until an arrow sign is shown to the left.
- 2] Scroll between measurements 1, 2 and 3 by using the ◀▶ keys.
Example: Three measurements on one label are shown as e.g. "1A1-1", "1A1-2", "1A1-3".

Note You can only scroll through the measurements in the selected LOG mode

5.7 Measurement using P/F and I min

In this example **LOG** is set to OFF.

- 1] Read the section 5.1 General instructions.
- 2] If applicable, connect the ground cable (protective earth).
- 3] Make the desired settings in the SET options. Select **P/F** and enter desired limit value. Select **I min** (50 or 100 A).
- 4] Attach the test cables.
- 5] Turn the function selector to desired **I > I min** position.
The instrument indicates that it is charging the capacitor by a repeated sound and on the display shows alternating "CAP" and "CHG" as well as the padlock symbol.



Charging

- 6] When the lock symbol disappears the MOM2 is ready for a measurement.

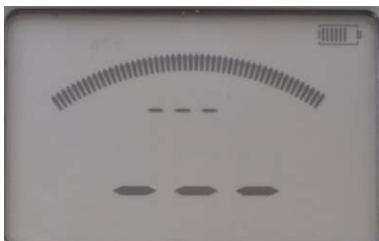

Ready for test

Press the **TEST** button on MOM2 or pull the trigger on the probe.
A continuous audio signal tells that the measurement is in progress.
When the measurement is complete there will be a pass or a fail signal.

- A] If the resistance value is below the **P/F** limit and the current value is over the set min

current limit the result will be shown on the display with big digits e.g. as below.
The small digits toggle between max and min current value and the **P/F** limit.



The minimum test current was 80 A and resistance is 102 $\mu\Omega$.

- B] If the resistance value is over the **P/F** limit there is the fail signal and the > character is displayed to the left of the set **P/F** value.



The small digits show the set **P/F** value (< 90 $\mu\Omega$).
The character ">" to the left of the big digits indicates that the **P/F** value was exceeded.

- C] If the current value is below the set min current limit there is the fail signal and the < character is displayed to the left of the set min current value.



The maximum test current was 82 A and the test current was below 100 A.

- D] If both the **P/F** limit and the current limit are contravened, the big digits will toggle between resistance value, < current limit and > **P/F** limit.

5.8 Trouble shooting

Problem	Solution
Headset does not work	Check that it is paired to MOM2
	Check on MOM2 that Bluetooth is enabled

Error messages

Message	Cause	Remedy
"OL"	Bad connection / resistance out of measurement range	Check cables and connections
Warning sign on display and the battery charge indicator blinks	The batteries cannot charge the capacitor	Charge the batteries Note: It might be possible to proceed and make some tests if it is realistic to select a test position that requires less power (shorter measuring time).
Warning sign on display	A thermal protection has tripped.	Turn off the MOM2 and let it cool down.

6 Application examples

6.1 Safety

Important regarding all testing



Important

**Read and comply with the safety instructions.
Always comply with local safety regulations.**

Note *If you are measuring resistance in a circuit breaker or disconnecting switch (isolator), make sure that it is closed and grounded at both sides before testing.*

6.2 Measurement using Kelvin probes

An example how to perform testing using the two Kelvin probes. This example describes the performance if you only want to know if the test object pass a preset value and you do not need to store the test results.

- 1] Select **LOG** function "OFF", and set **P/F** value (see section 4.6 and 4.7).
- 2] Attach the test cables with Kelvin probes (2 x 1.3 m) one with a trigger, to MOM2.
- 3] Turn the function selector to desired position.
- 4] Hook the instrument to your belt or use the strap.
- 5] Press and hold the two Kelvin probes to the test object and pull the trigger.
If the value is outside the limits there is a sound telling the result was fail.
The measurement value remains until another measurement is performed or until the instrument is switched off.

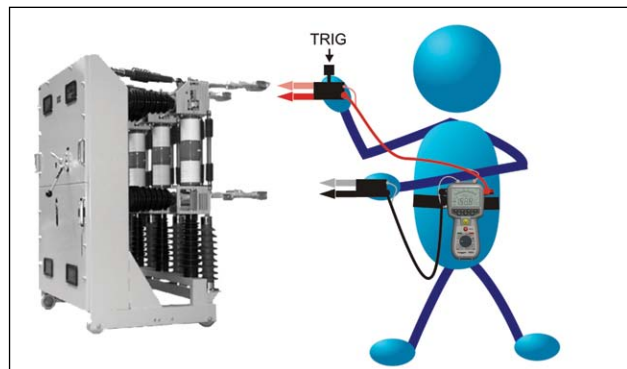

Measurement on a test object

6.3 Test a CB using DualGround

You can perform testing with both sides grounded. However the measurement accuracy will be somewhat lower with both sides grounded depending on the ratio of the currents – circuit breaker / grounding cables (see section 2.2). This example shows a test on a HV CB using a man lift.

- 1] The circuit breaker shall be disconnected, closed and grounded on both sides.
- 2] Attach the black (3 m) test cable with Kelvin clamp and the Kelvin probe with trigger to the instrument.
- 3] Hook the MOM2 to your belt or use the strap to hang it around your neck.
- 4] Attach the black test cable with Kelvin clamp to one side of the CB using the man lift.
- 5] Move yourself to the other side of the CB using the manlift.
- 6] Press and hold the Kelvin probe to the test object and pull the trigger.

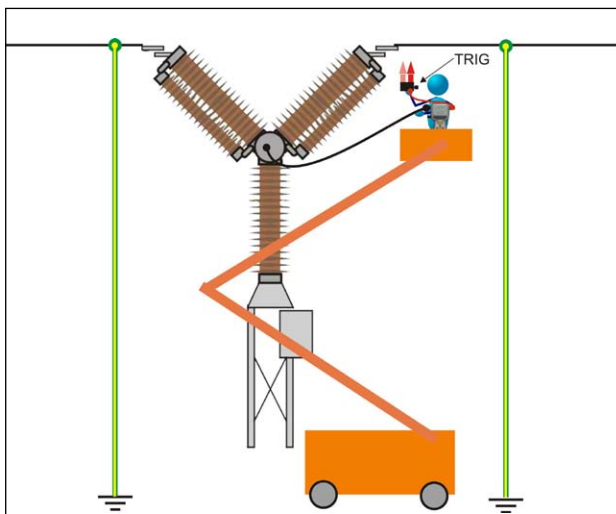

Measurement on CB with both sides grounded.

Note *The test can also be done by using two Kelvin clamps.*

6.4 Test a CB by injecting through the ground cables

- 1] The circuit breaker (CB) shall be disconnected, closed and grounded on both sides.
- 2] Connect the MOM2 to ground.
- 3] Attach an extra ground cable (not included) with at least 95 mm² cross section area to one side of the CB.
- 4] Connect the 0.5 m current cable to the current out minus terminal on the MOM2 and attach the other end to ground close to where the CB's grounding cable is attached. (the opposite side of CB from where the extra ground cable is attached).
- 5] Mount the 0.1 m plate to the current out plus terminal on the MOM2 and attach the extra ground cable to the plate.
- 6] Connect the sensing cables (red and black) to the CB.
- 7] Remove the original CB grounding cable on the side where the extra grounding cable is attached.
- 8] Press the **TEST** button.

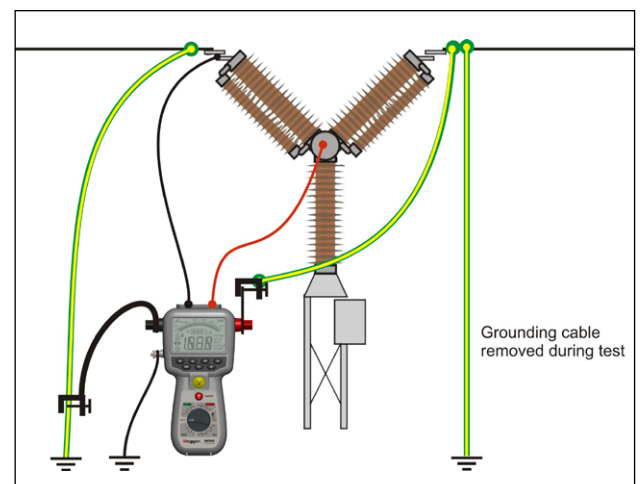

Traditional measurement from ground. Injection is done through existing grounding cable (earthing). Optional cable kit is needed. Available kits have 5, 10 or 15 m cables.

Disconnection

- 1] Re-attach the original CB grounding on the side where the extra grounding is attached.
- 2] Disconnect the sensing cables from the CB.
- 3] Disconnect the extra ground cable from the 0.1 m plate on plus terminal.
- 4] Disconnect the 0.5 m current cable from ground.
- 5] Disconnect the ground cable from MOM2.

8

MOM2 Win

8.1 Introduction

MOM2 Win is a Windows® program that communicates with the MOM2 microhmmeter instrument.

It is used for:

- Reading measurement data from the instrument and save it to file
- Configuring the instrument
- Calibrating the instrument

8.2 MOM2 installation

Preconditions

- Windows XP / 7
- .net Framework 4.0
If the PC has not the .net Framework 4.0 installed it will automatically be installed provided that the PC is connected to internet.
- USB Bluetooth dongle
The USB Bluetooth dongle must be installed, see the installation instructions supplied with the dongle.

Setup

- 1] Insert the MOM2 Win CD into the CD-drive.
The installation will start automatically. If not select and run the file "Setup.exe" to install the program.

The program will be installed in the folder C:\Program Files\Programma\Mom2 Win with program shortcuts on the desktop and in the Start->All programs->Programma folder.

Select language

- 1] Under "Settings" menu, select "Language".
All texts in all open windows will be updated with the selected language.

Note *If the translation is missing for some texts the default language (English) will be used.*

The language selection does not change the time format or decimal separator which instead follows the Windows regional settings.

8.3 Start MOM2 Win

- 1] Click the MOM2 icon on the desktop or run the file Mom2Win.exe (Start->All programs->Programma)
The program will startup showing the start page.

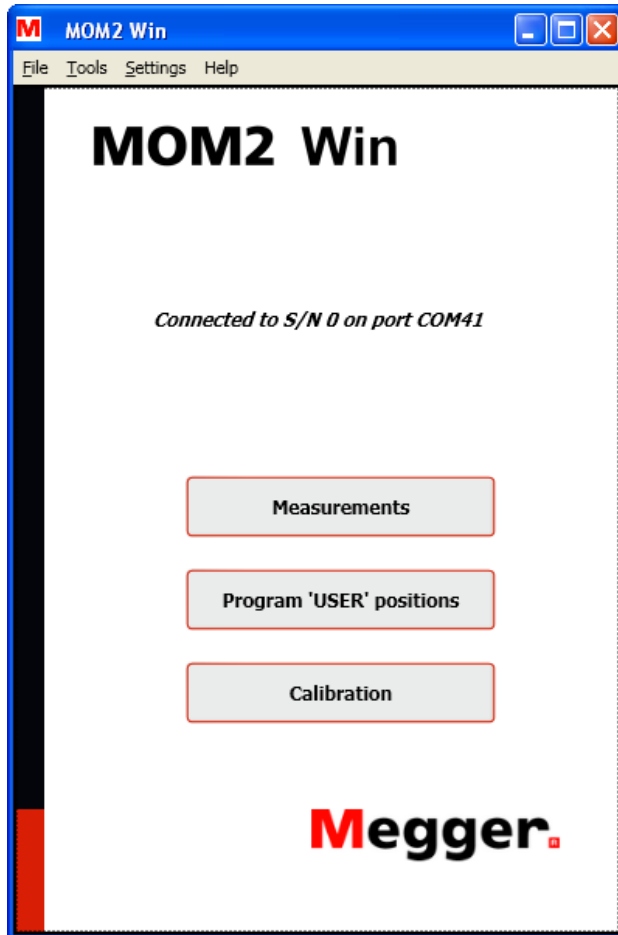

Figure 8.3.1 Start page

Exit MOM2 Win

- 1] Exit the program by selecting "Exit" from the "File" menu or by clicking on the "X" button in the upper right corner of the window. The program will ask for a confirmation before it closes.

8.4 Connecting to MOM2

To establish the Bluetooth connection the MOM2 must be paired to the PC, see section 4.3.

Automatic connecting

- 1] Turn the function selector to the **PC COM** position on the MOM2 instrument.

At program startup the SW will try to connect to MOM2 using the same COM port that the last successful connection used. If there have been no previous MOM2 connections from this computer the SW will scan all available COM ports. If there are several paired MOM2 instruments nearby the SW will connect to the first one detected. The connection status is shown on the start page, see Figure 8.3.1.

Manual connecting

- 1] Open the "Connection settings" window from the "Settings" menu or double-click on the connection status text field on the start page. The "Connection settings" window will then pop up, see figure below

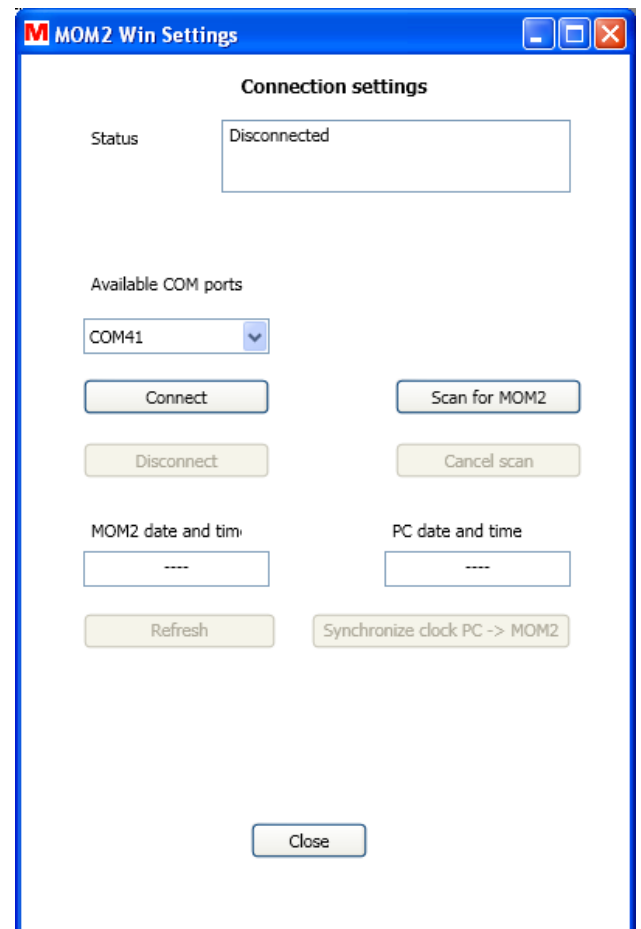

Figure 8.4.1 The Connection settings window, no connection established.

- 2] Choose a COM port in the drop down list and click the "Connect" button.
The program will try to connect to a MOM2 instrument over the specified COM port.

If it is unknown which COM port to use the program can scan all available ports until it finds a MOM2 instrument.

- 3] Click the button "Scan for MOM2".
The operation can be interrupted with the "Cancel scan" button.

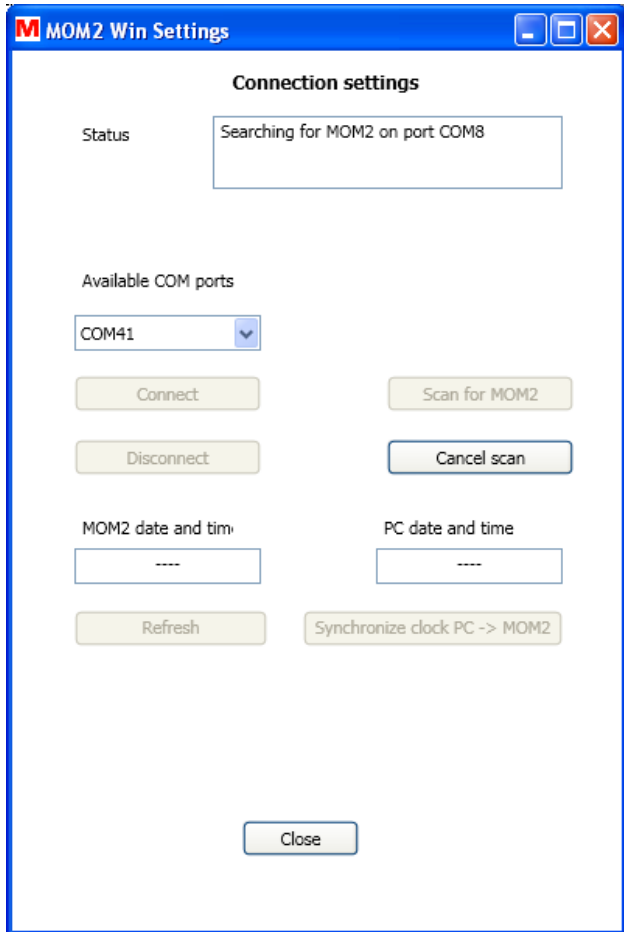

Figure 8.4.2 The Connection settings window, searching.



Figure 8.4.3 The Connection settings window, connection established.

Refresh button

Provided that the MOM2 and the PC are connected to each other the "MOM2 date and time" and the "PC date and time" fields are updated every time you open the "Connection settings" window or when you click the "Refresh" button, see Figure 8.4.3

Synchronize clock PC -> MOM2

When you click the "Synchronize clock PC -> MOM2" button the PC system time is written to the MOM2. This is the easiest way to set the clock in MOM2, see Figure 8.4.3

8.5 Read the measurement log

- 1] Click the "Measurements" button on the Start page or select "Measurements" from the "Tools" menu.

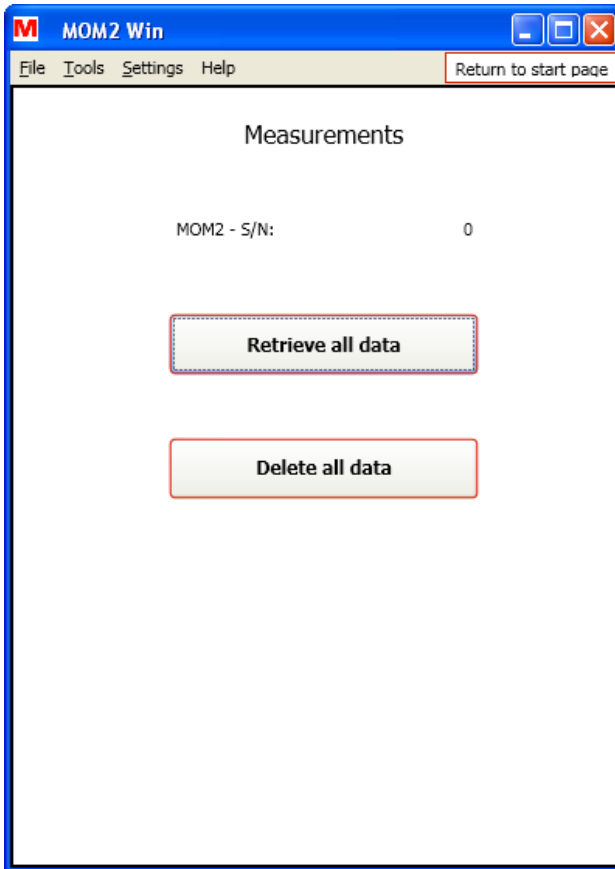

Figure 8.5.1 Data dumping dialog.

- 2] Click on the "Retrieve all data" button to download all measurements stored in the instrument.
 A window will pop up showing the progress of the download.
 At any time the data dump can be stopped by clicking the "Cancel" button. In that case the data window will be closed.

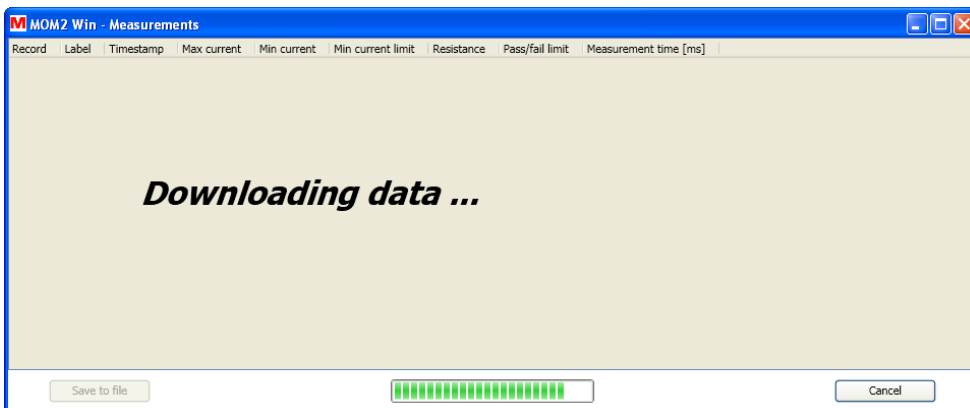

Figure 8.5.2 Data dumping progress.

Record	Label	Timestamp	Max current	Min current	Min current limit	Resistance	Pass/fail limit	Measurement time [ms]
1		19 2011-04-08 08:21:36	140 A	133 A	100 A	88 μΩ	90 μΩ	100
2		20 2011-04-08 08:23:49	243 A	229 A	0 A	88 μΩ	90 μΩ	100
17		17 2011-04-08 07:49:03	142 A	57 A	50 A	89 μΩ		3000
18		18 2011-04-08 07:49:16	79 A	63 A	50 A	85 μΩ		600
26		26 2011-04-08 07:54:52	57 A	54 A	50 A	85 μΩ	80 μΩ	100
27		27 2011-04-08 07:55:03	47 A	45 A	50 A	86 μΩ	80 μΩ	100
28		28 2011-04-08 07:59:20	43 A	41 A	50 A	88 μΩ	90 μΩ	100
29	1A1-1	2011-04-08 08:00:34	69 A	65 A	50 A	85 μΩ	90 μΩ	100
30	1A1-2	2011-04-08 08:00:43	69 A	65 A	50 A	86 μΩ	90 μΩ	100
31	1A1-3	2011-04-08 08:00:51	68 A	65 A	50 A	86 μΩ	90 μΩ	100
32	1A2-1	2011-04-08 08:01:10	67 A	64 A	50 A	87 μΩ	90 μΩ	100
33	1A2-2	2011-04-08 08:01:18	67 A	63 A	50 A	85 μΩ	90 μΩ	100
34	1A2-3	2011-04-08 08:01:26	67 A	63 A	50 A	86 μΩ	90 μΩ	100
35	1B1-1	2011-04-08 08:01:44	67 A	63 A	50 A	86 μΩ	90 μΩ	100
36	1B1-2	2011-04-08 08:01:53	67 A	63 A	50 A	87 μΩ	90 μΩ	100
37	1B1-3	2011-04-08 08:02:01	67 A	63 A	50 A	86 μΩ	90 μΩ	100
38	1B2-1	2011-04-08 08:02:12	67 A	64 A	50 A	86 μΩ	90 μΩ	100
39	1B2-2	2011-04-08 08:02:20	67 A	63 A	50 A	87 μΩ	90 μΩ	100
40	1B2-3	2011-04-08 08:02:28	67 A	63 A	50 A	87 μΩ	90 μΩ	100
41	1C1-1	2011-04-08 08:02:43	67 A	63 A	50 A	85 μΩ	90 μΩ	100
42	1C1-2	2011-04-08 08:02:51	67 A	63 A	50 A	85 μΩ	90 μΩ	100
43	1C1-3	2011-04-08 08:02:59	67 A	64 A	50 A	86 μΩ	90 μΩ	100
44	1C2-1	2011-04-08 08:03:15	67 A	63 A	50 A	86 μΩ	90 μΩ	100
45	1C2-2	2011-04-08 08:03:23	67 A	63 A	50 A	87 μΩ	90 μΩ	100
46	1C2-3	2011-04-08 08:03:32	67 A	63 A	50 A	88 μΩ	90 μΩ	100
47	2C1-1	2011-04-08 08:04:03	67 A	63 A	50 A	86 μΩ	90 μΩ	100
48	2B1-1	2011-04-08 08:04:16	67 A	63 A	50 A	85 μΩ	90 μΩ	100
49	2A1-1	2011-04-08 08:04:29	67 A	63 A	50 A	87 μΩ	90 μΩ	100

Figure 8.5.3 Data dumping finished. The columns can be sorted by clicking the headers and arranged by click-hold and drag.

Export data to file

- 1] Click the "Save to file" button (this button is not enabled if the list is empty).
A "Save as" window will be opened.
 - 2] Type a file name and click the "Save" button to export the data to file.
- A]** The default file type is (*.csv) which will save the data as an ASCII file with comma separated values, suited for import to e.g. Microsoft Excel.

Note *The value separator is dependent of the regional setting in Windows, a semicolon when comma is used for decimal separator and comma otherwise.*

The format of the exported data is not the same as what is seen in the measurements table. There is no mixing of values and units, the units are placed in the column headers.

- B]** If file type (*.txt) is selected the data will be saved with the values separated by tabs.

Delete all data on the instrument

- 1] In the "Measurements" window, click the "Delete all data" button to erase all the measurements in the instrument log.

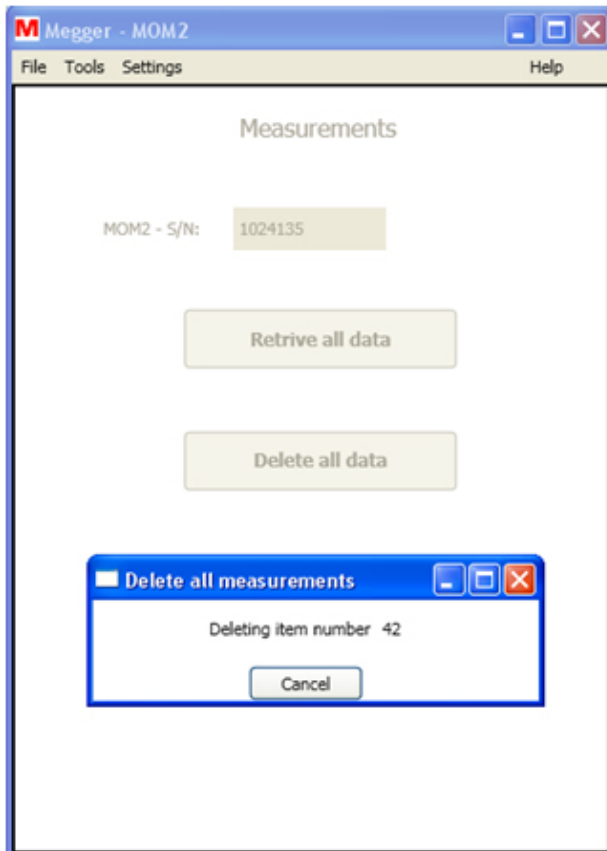

Figure 8.5.4 Delete all measurements progress.

8.6 User settings

- 1] Click the Program "User" positions" button on the start page or choose Program "User" positions from the "Tools" menu .

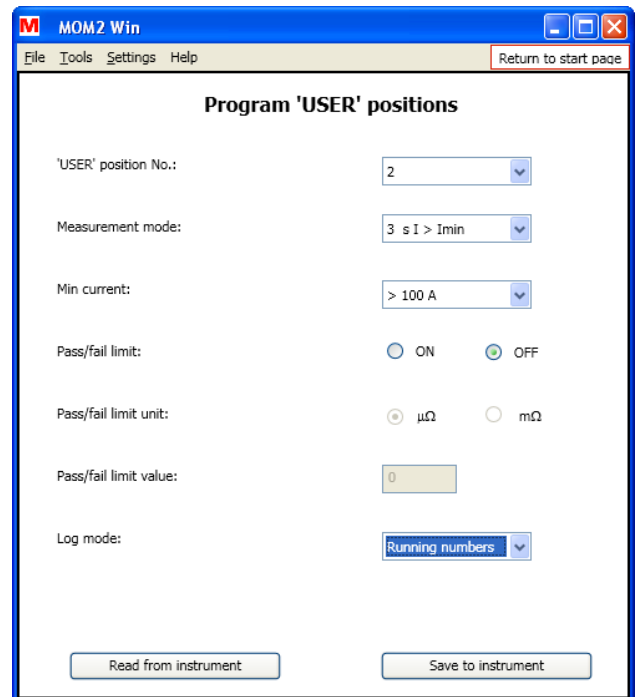

Figure 8.6.1 Program "User" positions

Read existing settings

- 1] Select "User" position No." (1 – 3).
- 2] Click the "Read from instrument" button to see the current settings on the instrument. All three user settings will be read, not only the one selected in the combo box. The values for minimum current, pass/fail limit and type of logging will be updated.

Program "User" positions

- 1] Make the desired settings and click the "Save to instrument" button.

Note *All three User positions will be updated on the instrument, not just the currently selected one.*

8.7 Calibration

Required equipment

- Stable DC voltage source
- Calibrated reference voltmeter
- Reference shunts 1 mΩ and 10 mΩ

Procedure

- 1] Click the "Calibration" button on the Start page or select "Calibration" from the "Tools" menu to switch to the calibration page. The existing calibration factors will be read from the instrument and the calibration page will be disabled until it is finished.

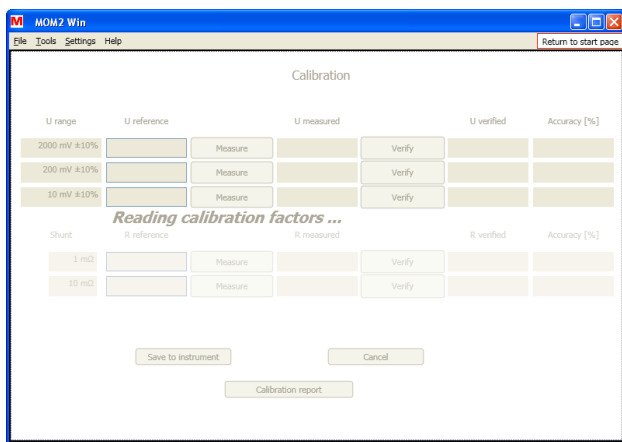

Figure 8.7.1 Calibration page. Loading calibration factors during startup.

Voltmeter calibration

The voltmeter should be tested in three ranges.

- 1] Connect the voltage source to the MOM2 sense input, correctly polarized
- 2] Adjust voltage so that it falls within $\pm 10\%$ of the stated reference voltage, using the calibrated voltmeter.
- 3] Type the value in the U reference column in MOM2 Win
- 4] Click the "Measure" button next to the field. The value measured by the MOM2 will then be propagated to the "U measured" text field. New calibration factors will automatically be calculated.
- 5] Click the "Verify" button. The voltage measured with the new calibration factor will be shown in the "U Verified" field. The deviation (in percent) from the reference value will be shown to the right.

- 6] Repeat from step 1 for the next two ranges.

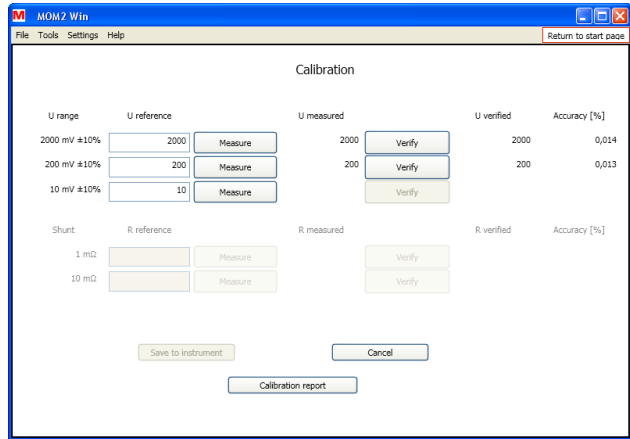

Figure 8.7.2 Voltmeter calibration

Ammeter calibration

Note *The voltmeter in the instrument must be calibrated before it is possible to calibrate the Ammeter.*

The ammeter is calibrated in an indirectly manner by measuring the resistance over two predefined shunts and compare with the reference values. The resistance is measured with a capacitor voltage suitable for the voltage and current ranges.

- 1] Connect the current cables from the MOM2 to the reference shunt
- 2] Connect separate sense leads from the MOM2 sense input to the sense outputs of the reference shunt
- 3] Enter the value of the shunt in the "R reference" input field. The "Measure" button will be enabled if the resistance is within the limits.
- 4] Click the "Measure" button next to the field. When the measurement is started a progress window is shown, see fig. below. The two uppermost fields show the measured capacitor voltage and the target voltage.

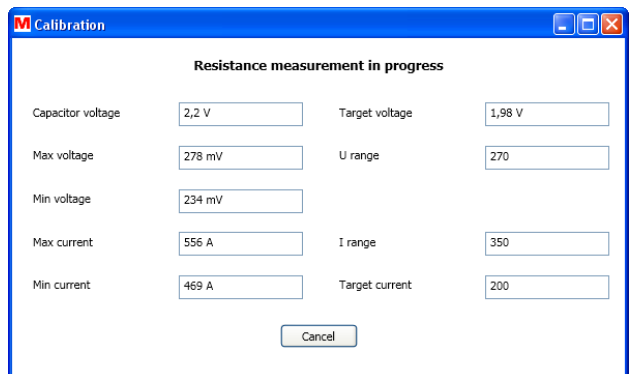

Figure 8.7.3 Resistance measurement progress window

- 5] The measurement goes on and when it is finished the "R Measured" field is filled with the measured resistance value and a new calibration factor for this measurement range is calculated, see fig. below.

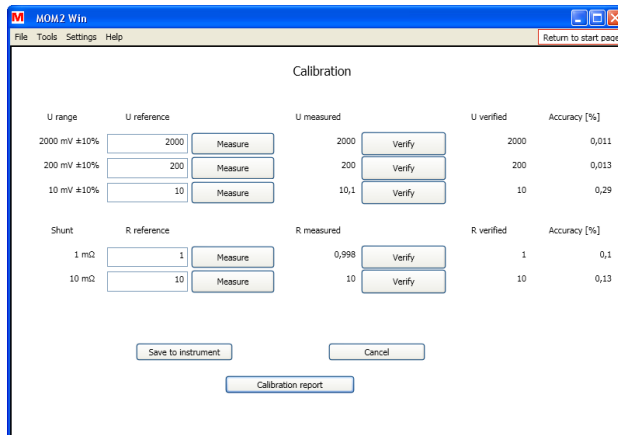

Figure 8.7.4 Ammeter calibration.

- 6] Click the "Verify" button.
A measurement is started and the "Resistance measurement in progress" window will be shown.
- 7] Repeat from step 1 for the next reference shunt.
When the resistances over both the shunts have been measured and the result is satisfactory you can save it to the MOM2.
- 8] Click the "Save to instrument" button.
- 9] If the result of the tests is not satisfying or you want to start over, click the "Cancel" button.
This will empty the calibration dialog and the calibration factors are read from the instrument again.

Calibration report

- 1] Click the "Calibration Report" button to show a preview of a calibration report.
It can be opened at any time during the calibration. However, a complete report with a calibration time can only be made when the calibration is completed and saved to the MOM2.
- 2] The calibration report can be printed, either by pressing ctrl-P or clicking on the "Print report" button.

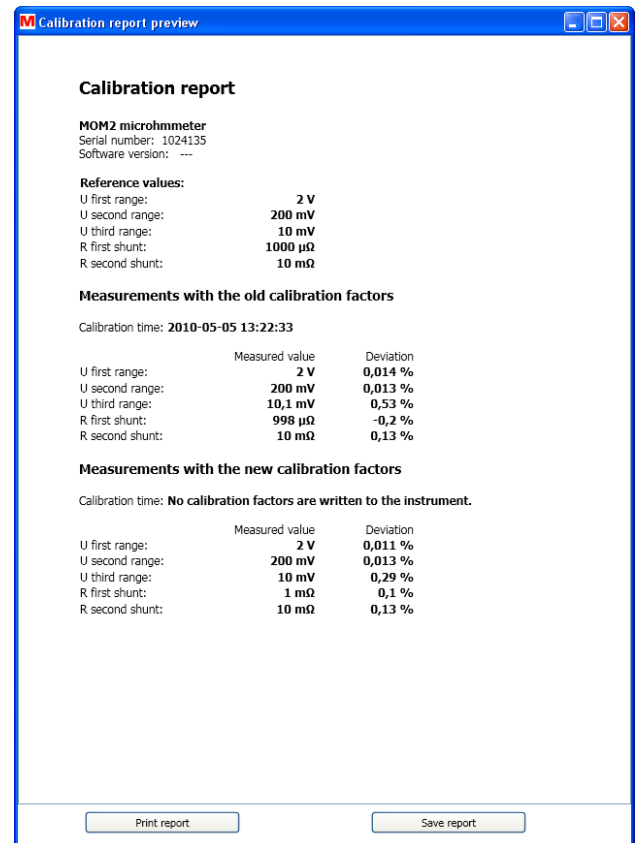

Figure 8.7.5 Calibration report.

9 Specifications

Specifications MOM2

Specifications are valid at fully charged batteries and an ambient temperature of +25°C, (77°F). Specifications are subject to change without notice.

Environment

<i>Application field</i>	For use in high-voltage substations and industrial environments.
<i>Temperature</i>	
<i>Operation</i>	-20°C to +50°C (-4°F to +122°F) *)
<i>Storage</i>	-40°C to +70°C (-40°F to +158°F)
<i>Relative humidity %RH</i>	5%-95%, non condensing
<i>Pollution degree</i>	2
<i>Shock</i>	IEC 60068-2-27
<i>Vibration</i>	IEC 60068-2-6
<i>Transport</i>	ISTA 2A
<i>Flammability class</i>	V0
*) Battery operation temperature 0°C to +50° (32°F to +122°F) *) Battery charging temperature +10°C to +40° (50°F to +104°F)	

CE-marking

<i>EMC</i>	2004/108/EC
<i>LVD</i>	2006/95/EC

General

<i>Battery power</i>	Five AA (HR6) 2700 mAh NiMH cells
<i>Recharge time</i>	< 12 h
<i>Typical recharge time at 25°C</i>	3 h
<i>Battery charger</i>	
<i>Mains voltage</i>	100-250 V AC, 50 / 60 Hz
<i>Power consumption</i>	60 W
<i>Protection</i>	Against wrong battery type, low/high temperature.
<i>Real time clock battery life</i>	≥10 years
<i>Audible feedback</i>	Different buzzer sounds
<i>User presets</i>	3
<i>Field calibration</i>	Yes
<i>Encapsulation</i>	IP54
<i>Dimensions (excl. binding posts)</i>	217 H x 92 B x 72 D mm 8.5 H x 3.6 B x 2.8 D in.
<i>Weight</i>	1.0 kg (2.2 lbs) instrument only 5.0 kg (11 lbs) with accessories and carrying case

Measurement section

<i>Minimum current guarantee</i>	Selectable 50 A / 100 A Valid at resistance ≤2mΩ
<i>Pass / Fail</i>	Settable from 1 μΩ to 1999 mΩ
<i>Number of measurements on fully charged batteries</i>	typ. 2200 at I min = 50 A and 0.1 s typ. 800 at I min = 100 A and 0.1 s
<i>Interference suppression</i>	Yes
<i>Range</i>	0 - 1000 mΩ
<i>Range selection</i>	Auto
<i>Resolution</i>	
0 - 999 μΩ	1 μΩ
1.0 - 9.99 mΩ	0.01 mΩ
10.0 - 99.9 mΩ	0.1 mΩ
100 - 1000 mΩ	1 mΩ
<i>Inaccuracy</i>	
0 - 1999 μΩ	±1 % of reading ±1 digit
2 - 1000 mΩ	±2 % of reading ±1 digit

Outputs + / -

<i>Range</i>	> 100 A DC (R < 2 mΩ)	
<i>Output voltage (max)</i>	2.5 V DC	
<i>Generation duration</i>	Selectable: 0.1 s, 0.6 s, 3 s	
	Recovery time at I min set to 100 A and load 100 μΩ	
Generation time	Max	Typ
0.1 s	10 s	8 s
0.6 s	20 s	16 s
3 s	130 s	100 s

Inputs

<i>SENSE + / -</i>	
<i>Connector</i>	4 mm banana jack
<i>Voltage</i>	±3 V DC
<i>Trigger input</i>	Threshold 8 V DC
<i>DC IN</i>	12 - 24 V DC, 2 A max

Logger

<i>Logger, Data</i>	Label, Timestamp, I max, I min, I Limit, Resistance, Meas.time, P/F limit
<i>Labeling schemes</i>	Circuit breaker oriented or running numbers
<i>Capacity</i>	190 measurements

Wireless communication

<i>Headset</i>	Bluetooth
<i>PC communication</i>	Bluetooth
<i>PC communication</i>	Bluetooth

Index

A		J	
Accessories	12	Input for sensing voltage (-)	11
Application examples	32	Input for sensing voltage (+)	11
Audio signals	20		
B		K	
Basic technical description	8	Kelvin Clamp/Probe practice	23
Battery charging	21	Kelvin test	8
Battery charging indicator	11	Keys	11
Battery charging LED indicator	21		
Battery lid	11	L	
Battery power supply	21	LCD display	22
Bluetooth	15	LOG	18
Both sides grounded	9	low temperatures	23
C		M	
Calibration	40	Measurement on using Kelvin probes	32
Clear log	11	measurement time	22
CLK	17	Measurement using P/F	26
Clock	17	Measurement using P/F and I min	29
Connector for the battery charger	11	Measurement using the LOG function	27
Connectors for trigger	11	Measurement with max. charge, I=I MAX	24
Current output terminal (-)	11	Measurement with minimum current guarantee, I>I MIN	25
Current output terminal (+)	11	Measurement with user defined settings	27
		MOM2 installation	34
D		MOM2 Win	34
Delete all results	23	N	
Delete present test result	23	O	
Delete results	23	OFF	14
display	22	Operating instructions	22
Display	11	Optional accessories	12
DualGround	9	overview	10
E		P	
F		Pass/Fail	19
Functions	14	PC COM	20
Functions and set up	14	PC communication	20
Function selector	11	P/F	19
G		Protective conductor terminal	11
H		Q	
Hold present test result	23	R	
I		Recalling test results	23
I min	18	Replacing batteries	21
		S	
		Safety	6
		Safety instructions	6

Save test results	23
set up	14
Specifications.....	42
Stand-by / Wake up	11
Symbols on the instrument	6

T

Test a CB by injecting through the ground cables	33
Test a CB using DualGround.....	33
TEST button.....	11
Test positions	14
To choose $I > I_{min}$ or $I = I_{max}$	22
To choose measurement time.....	22
Trouble shooting.....	30

U

USER-1/2/3	14
------------------	----

V**W**

Wake up.....	11
--------------	----

X**Y****Z**

Your "One Stop" Source for all your electrical test equipment needs

- Battery Test Equipment
- Cable Fault Locating Equipment
- Circuit Breaker Test Equipment
- Data Communications Test Equipment
- Fiber Optic Test Equipment
- Ground Resistance Test Equipment
- Insulation Power Factor (C&DF) Test Equipment
- Insulation Resistance Test Equipment
- Line Testing Equipment
- Low Resistance Ohmmeters
- Motor & Phase Rotation Test Equipment
- Multimeters
- Oil Test Equipment
- Portable Appliance & Tool Testers
- Power Quality Instruments
- Recloser Test Equipment
- Relay Test Equipment
- T1 Network Test Equipment
- Tachometers & Speed Measuring Instruments
- TDR Test Equipment
- Transformer Test Equipment
- Transmission Impairment Test Equipment
- Watthour Meter Test Equipment
- STATES® Terminal Blocks & Test Switches
- Professional Hands-On Technical and
- Safety Training Programs

Megger is a world leading manufacturer and supplier of test and measurement instruments used within the electric power, building wiring and telecommunication industries.

With research, engineering and manufacturing facilities in the USA, UK and Sweden, combined with sales and technical support in most countries, Megger is uniquely placed to meet the needs of its customers worldwide.

For more information about Megger and its diversified line of test and measurement instruments:
www.megger.com

Megger is certified according to ISO 9001 and 14001.

Megger is a registered trademark



SWEDEN

Megger Sweden AB
Eldarvägen 4
Box 2970
SE-187 29 TÄBY
T +46 8 510 195 00
F +46 8 510 195 95
E seinfo@megger.com

UK

Archcliffe Road, Dover
CT17 9EN England
T +44 (0) 1304 502101
F +44 (0) 1304 207342
E UKsales@megger.com

Other Technical Sales Offices

Dallas USA
Norristown USA
Toronto CANADA
Trappes FRANCE
Oberursel GERMANY
Johannesburg SOUTH AFRICA
Kingdom of BAHRAIN
Mumbai INDIA
Chonburi THAILAND
Sydney AUSTRALIA

Megger

WWW.MEGGER.COM